

Centrifugation

1. Principles of Centrifugation / theory and key equations

$$F_s = m\omega^2 r = \frac{M}{N} \omega^2 r$$

where ω = angular velocity (radians / sec)

r = radius of particle from axis of rotation

note: ω (1/sec) = rpm x (2 π rad / rev) x (1 min / 60 sec)

$$\text{RCF (Rel. Centrifugal Force)} = \frac{F_c}{F_g} = \frac{m\omega^2 r}{ma} = \frac{(2\pi \text{ rpm}/60)^2 \times r}{980 \text{ cm/sec}^2}$$

$$= 1.119 \times 10^{-5} (\text{rpm})^2 r$$

for $r = 9.0 \text{ cm}$

rpm	1000	5000	10,000	20,000	40,000
RCF	100	2500	10,000	40,000	160,000

Sedimentation of Particles in a Gravitational Field

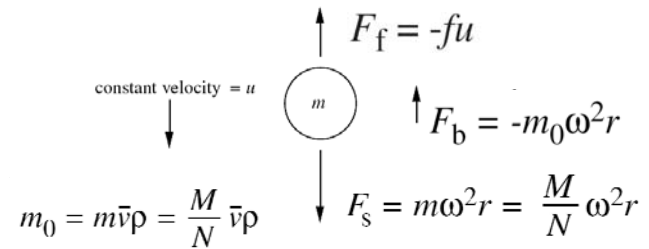

$$F_s + F_b + F_f = 0$$

$$\frac{M}{N} \omega^2 r - \frac{M}{N} \bar{v}\rho \omega^2 r - fu = 0$$

$$\frac{M}{N} (1 - \bar{v}\rho) \omega^2 r - fu = 0$$

$$\frac{M(1 - \bar{v}\rho)}{Nf} = \frac{u}{\omega^2 r} \equiv s$$

Table 1. Approximate Values of Partial Specific Volumes for Common Biological Macromolecules

Substance	\bar{v} (mL/g)	
Proteins	0.73	(0.70-0.75)
Polysaccharides	0.61	(0.59-0.65)
RNA	0.53	(0.47-0.55)
DNA	0.58	(0.55-0.59)

Data from Beckman review article by Greg Ralston.

Use of Centrifugation in Biochemistry

$$\frac{M(1 - \bar{v}\rho)}{Nf} = \frac{u}{\omega^2 r} \equiv s$$

1. Preparative Centrifugation

- rotors
- density gradient methods
 - sucrose gradients / isopycnic methods (CsCl gradients)

2. Analytical Ultracentrifugation

- instrument and **optic systems**
- **sedimentation velocity** experiments
 - sed. coefficient (s) ($S = 10^{-13}s$)
- **sedimentation equilibrium** exp.
 - molecular weight

- **diffusion constants** / $D = \frac{RT}{Nf}$

Centrifuge Rotors

A. Fixed Angle Rotor

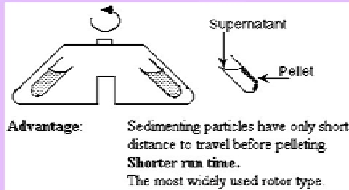

B. Swinging Bucket Rotor

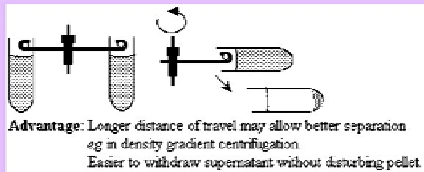

<http://www.resonance-pub.com/centrifuge.htm>

10.4 Density Gradient Centrifugation

In absence of a density gradient, separated bands of solute in the centrifuge are gravitationally unstable.

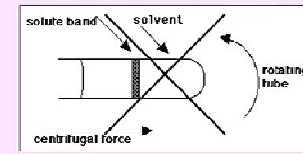

CANT OCCUR because layer of concentrated, dense solution overlaying less dense solvent would lead to mixing by convection and nullify the separation. In absence of stabilising density gradient, can form **boundaries** (of electrophoresis *2,3*) but **not zones**. In **analytical ultracentrifuge**, moving boundaries and concentration distributions observed by optical device.

Create DENSITY GRADIENT in tube

Use a non-interacting, low M.W. solute in continuously increasing concentration from meniscus to bottom of tube.

Important technique for purifying **proteins** and particularly **nucleic acids**.

Two different types of density gradient centrifugation, for two different purposes are:

- **Zonal (or Rate Zonal) Centrifugation** (Sucrose density gradient centrifugation)
- **Isopycnic Centrifugation** (Cesium chloride density gradient centrifugation)

<http://www.resonance-pub.com/centrifuge.htm>

Zonal Centrifugation

<http://www.resonance-pub.com/centrifuge.htm>

Mixture to be separated is layered on top of a **SUCROSE, or FICOLL, GRADIENT** (increasing concentration down the tube) - provides gravitational stability as different species move down tube at different rates forming separate bands.

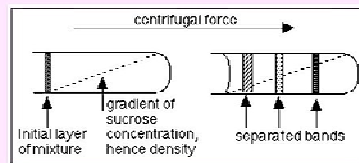

Species are separated by differences in **SEDIMENTATION COEFFICIENT (S)**

$$= \frac{\text{Rate of movement down tube}}{\text{Centrifugal force}}$$

S is increased for particle of **LARGER MASS** (because sedimenting force $\propto m(1 - \rho_f)$)

S is also increased for **MORE COMPACT STRUCTURES** of equal particle mass (frictional coefficient is less)

MB4, non-densitizing procedure, useful for protein purification, and for intact cells and organelles.

Isopycnic Centrifugation

Molecules separated on **EQUILIBRIUM POSITION, NOT** by RATES of sedimentation. Each molecule floats or sinks to position where density equals density of CsCl solution. Then no net sedimenting force on molecules.

Isopycnic = Equal density and separation is on basis of **DIFFERENT DENSITIES** of the particles.

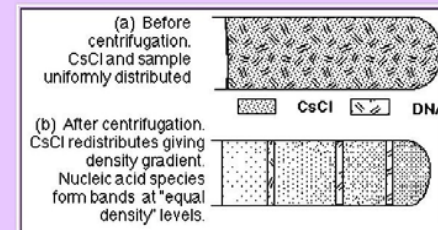

Very useful for purifying **nucleic acid** species of different density; also in separating **proteoglycans** extracted from cartilage.

<http://www.resonance-pub.com/centrifuge.htm>

Analytical Ultracentrifuge: The sorts of questions for which answers are sought

- (1) Is the sample homogeneous? Is it pure?
- (2) If there is a single component, what is the molecular weight?
- (3) If more than one type present, can the molecular weight distribution of the sample be obtained?
- (4) Can an estimate be obtained of the size and shape of the particles? Are the molecules compact and spherical (globular) or long and thin (rod-like)?
- (5) Can the macromolecules be distinguished on the basis of density?
- (6) Can interactions between solute molecules be detected? Aggregation between molecules changes molecular weight, changes in molecular weight as a function of the concentrations of the components can illuminate the type of reaction (e.g., reversible or nonreversible?), the stoichiometry, and the strength of binding.
- (7) Can changes in conformation or shape of the particles be measured?

Conformational Changes

X-ray diffraction and **NMR techniques** are currently the only techniques available that are capable of providing structural details at **atomic resolution**.

Nevertheless, **the overall size and shape of a macromolecule or complex in solution can be obtained through measurement of the rate of movement of the particles through the solution**. Sedimentation velocity experiments in the analytical ultracentrifuge provide **sedimentation and diffusion coefficients** that contain information concerning the **size and shape** of macromolecules and the interactions between them. Sedimentation coefficients are particularly useful for monitoring **changes** in conformation in proteins.

Molecular Weight Determination

Light scattering / Centrifugation / Osmometry / X-ray diffraction

Electrophoresis and chromatographic methods are popular for rapid estimation of molecular weights of proteins and nucleic acids. However, such methods, though rapid and sensitive, have **no rigorous theoretical base**; **they are empirical techniques** that **require calibration and assumptions** that may be invalid.

The **analytical ultracentrifuge** enables the **direct measurement of molecular weights** of solutes in the **native state** and as they exist in solution, **without calibrations or assumptions concerning shape**. The method is applicable to molecules with molecular weights ranging from several hundreds (sucrose) up to many millions (virus particles).

Sedimentation equilibrium methods require only **small sample sizes (20-120 μL)** and **low concentrations (0.01-1 g/L)**.

Sedimentation of Particles in a Gravitational Field

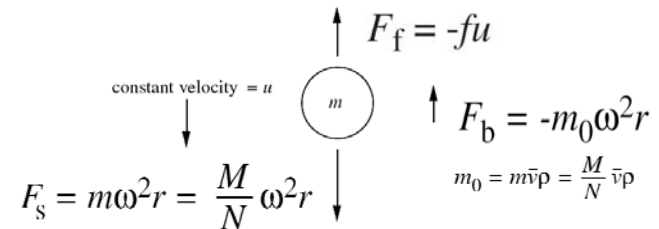

$$\frac{M(1 - \bar{v}\rho)}{Nf} = \frac{u}{\omega^2 r} \equiv s$$

$$D = \frac{RT}{Nf}$$

$$M = \frac{s^0 RT}{D^0(1 - \bar{v}\rho)}$$

Centrifugation: Terms and Units

Force: mass x acceleration ($F = ma = m\omega r^2$)

Energy: force x distance

Viscosity: η (~0.01 g (cm-sec))

Frictional Coefficient: $f = 6 \pi \eta R$ (~ 10^{-8} g/sec)

Sedimentation Coefficient: s (sec) [$1S = 10^{-13}$ s]

Diffusion Constant: $D = \frac{RT}{Nf}$ (cm²/s)

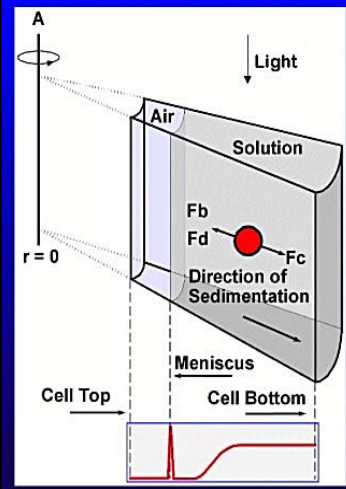

Sedimentation:

Forces at Equilibrium:

$$F_c - F_b - F_d = 0$$

F_b (buoyancy) = $\omega^2 r m_o$
 F_d (viscous drag) = $f v$
 F_c (centrifugal force) = $\omega^2 r m$

Explanation:

F_b is the buoyancy force - the force required to displace the buffer surrounding the solute, and m_o is the mass of the displaced solvent.

XL-A Analytical Ultracentrifuge

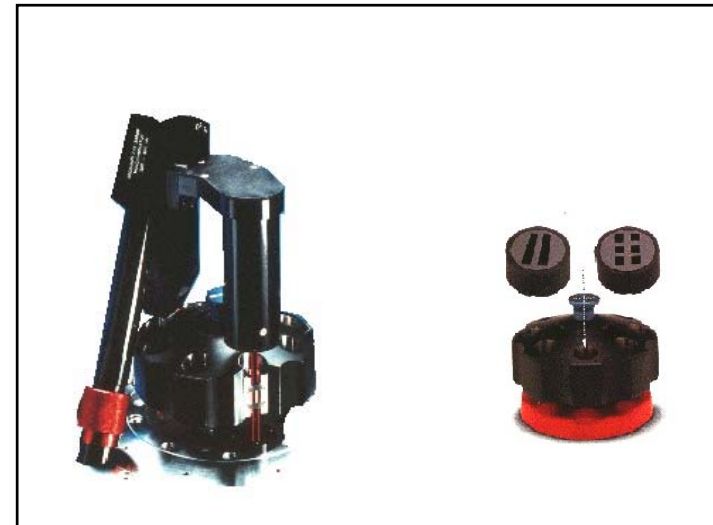
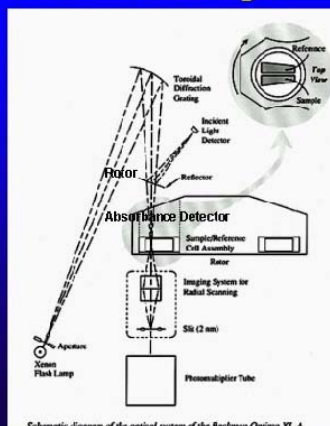
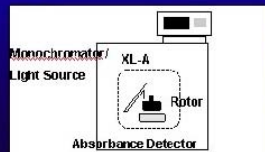

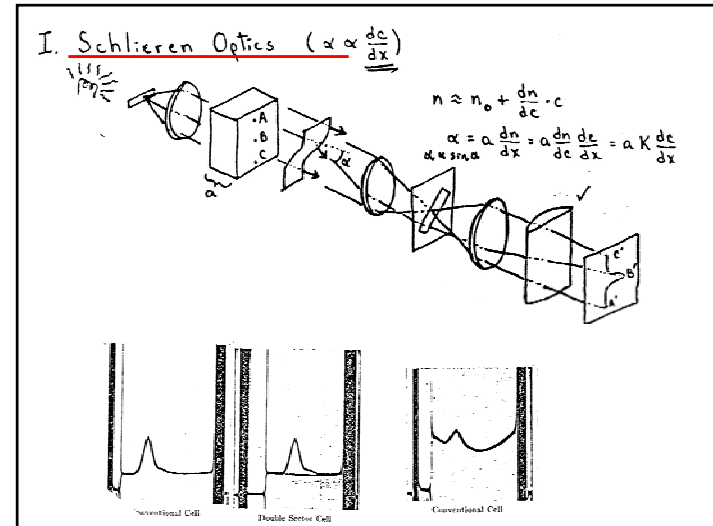
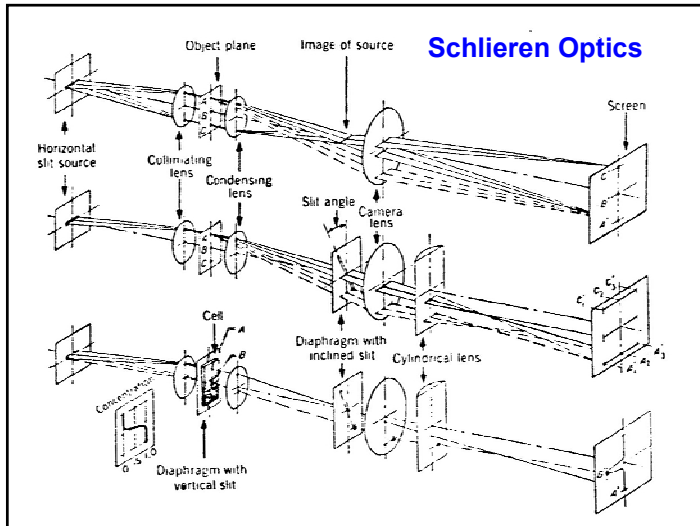
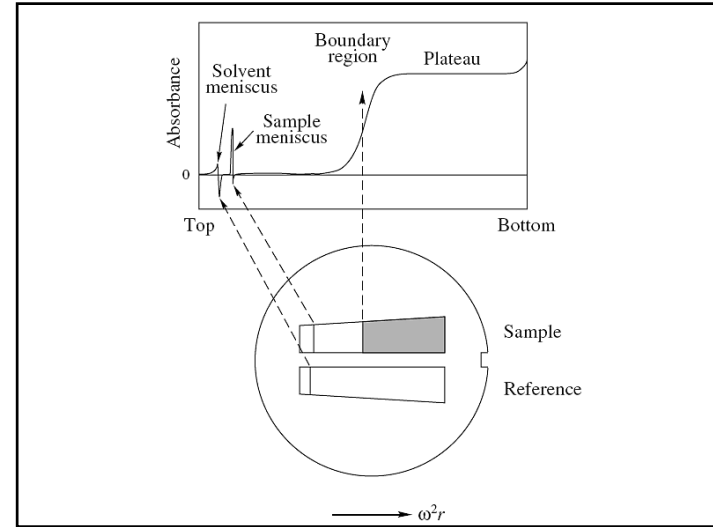
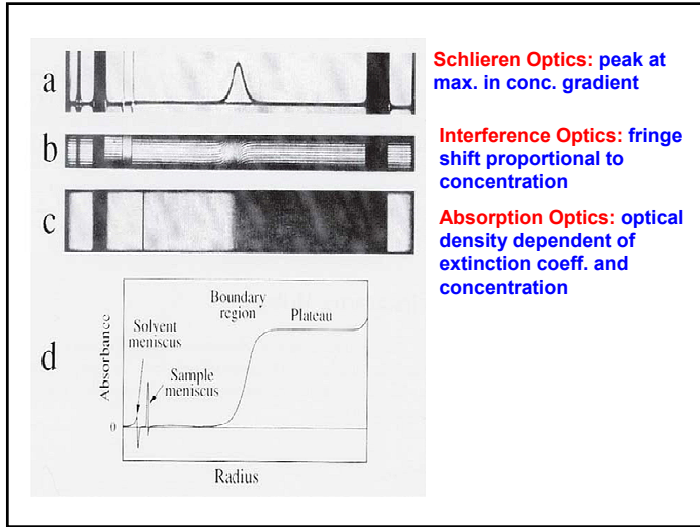

II. Interference Optics ($\Delta J \propto \Delta c$)

Count along this line $Y = Y_0$ 0 1 2 3 4 5 6 7 8 Y_f Y_f
 Fractional Fringe = $\frac{Y_f - Y_0}{\Delta Y}$

Fringe with $\Delta c = \Delta n = 0$
 shifted fringe

$\Delta J = \frac{a}{\lambda} (\Delta n) = \frac{a}{\lambda} \left(\frac{dn}{dc} \right) \Delta c$ or $\Delta J = \frac{\Delta J - \lambda}{a \cdot K}$ **ΔJ from fringes**

$\Delta t = \frac{r_2^2 - r_1^2}{2v} = \frac{r_2^2 - r_1^2}{2v} \Delta n$

refractive index increment

$\frac{dn}{dc} = K = 0.186 \text{ (g/cm}^3\text{)}^{-1} ; a = 12 \text{ mm} ; \lambda = 546 \text{ nm}$

How can we measure s in the Ultracentrifuge?

$$\frac{M(1 - \bar{v}\rho)}{Nf} = \frac{v}{\omega^2 r} = s$$

Express the velocity in terms of a derivative: $v = \frac{dr}{dt} = \omega^2 r s$

Integrate:

$$\int_{r=a}^{r=b} \frac{1}{r} dr = \omega^2 s \int_{t=0}^t dt$$

$$s = \ln\left(\frac{r_b(t)}{r_a(t_0)}\right) [\omega^2 (t - t_0)]^{-1}$$

The XLA provides both $\omega^2 \Delta t$ and the radial positions, r

Sedimentation Velocity

center of rotation ($r = 0$) meniscus boundary forms with concentration = 0 above it molecules pile up at the bottom boundary moves down the tube

$$s \equiv \frac{u}{\omega^2 r} = \frac{dr_{\text{bnd}}/dt}{\omega^2 r}$$

$$\ln(r_{\text{bnd}}/r_m) = s\omega^2 t$$

Radius

$$s \equiv \frac{u}{\omega^2 r} = \frac{dr_{\text{bnd}}/dt}{\omega^2 r}$$

$$\ln(r_{\text{bnd}}/r_m) = s\omega^2 t$$

Recall: $s = \frac{v}{\omega^2 r} = \frac{1}{\omega^2} \frac{1}{r} \frac{dr}{dt}$ This is a Differential Equation which we can easily solve by separating the variables and integrating:

$$\int_0^t \omega^2 s dt = \int_{r_0}^{r_1} \frac{1}{r} dr \implies \omega^2 s (t - t_0) = \ln \frac{r_1}{r_0}$$

We integrate between $t = t_0$ ($r = r_0$) and $t = t$ ($r = r_1$); r_0 is the boundary position at the start ($t = t_0$) and r_1 is the boundary position at later time(s). Thus, if we plot $\ln \frac{r_1}{r_0}$ vs. $(t - t_0)$, the result is a straight line with a slope = $\omega^2 s$.

$$s_{20,w} = s_{\text{obs}} \left(\frac{\eta_{T,w}}{\eta_{20,w}} \right) \left(\frac{\eta_s}{\eta_w} \right) \left(\frac{1 - \bar{v}\rho_{20,w}}{1 - \bar{v}\rho_{T,s}} \right)$$

Flow in the Ultracentrifuge Cell:

Sedimentation:
$$\frac{M(1 - \bar{v}\rho)}{Nf} = \frac{v}{\omega^2 r} = s$$

Diffusion:
$$D = \frac{RT}{Nf}$$

Molecular Weight:
$$\frac{s}{D} = \frac{M(1 - \bar{v}\rho)}{RT}$$

The ratio of s/D is proportional to the Molecular weight

$$f = 6\pi\eta R \quad D = \frac{RT}{Nf}$$

$$M = \frac{s^0 RT}{D^0(1 - \bar{v}\rho)}$$

Radius (cm)

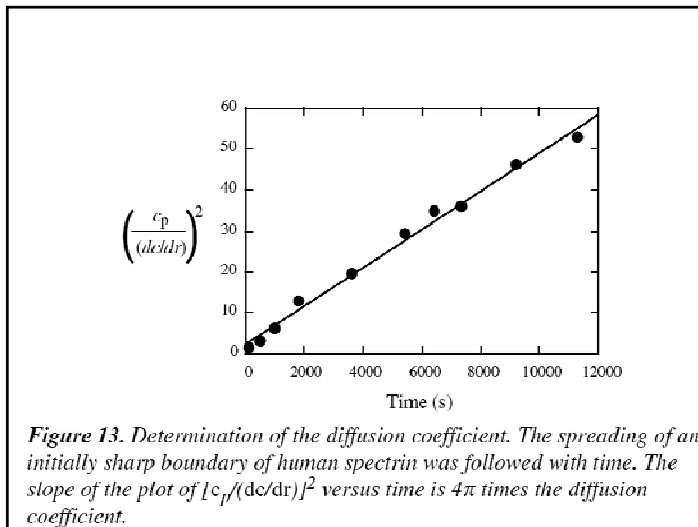

Figure 1: A single-component system shown without diffusion (in blue) and with diffusion (in red). The boundary spreads due to diffusion and gives a sigmoidal shape to the boundary.

Figure 2: A multi-component system shown without diffusion (in blue) and with diffusion (in red). The step functions defining the boundary profiles of each component can lose definition as diffusion increases and overlays on top of sedimentation separation.

Figure 3: A single- or multi-component system? The boundary profile is shown with a step-like transition.

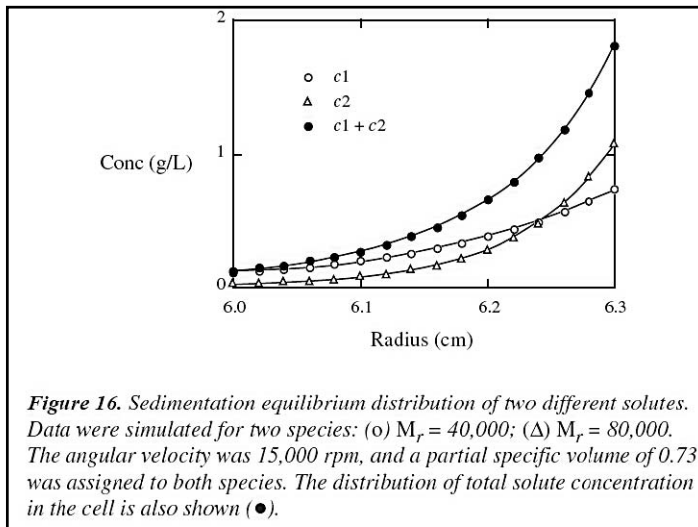
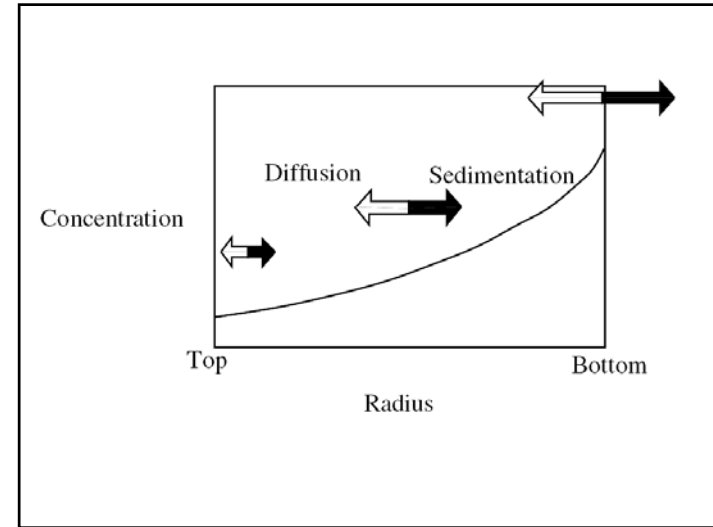
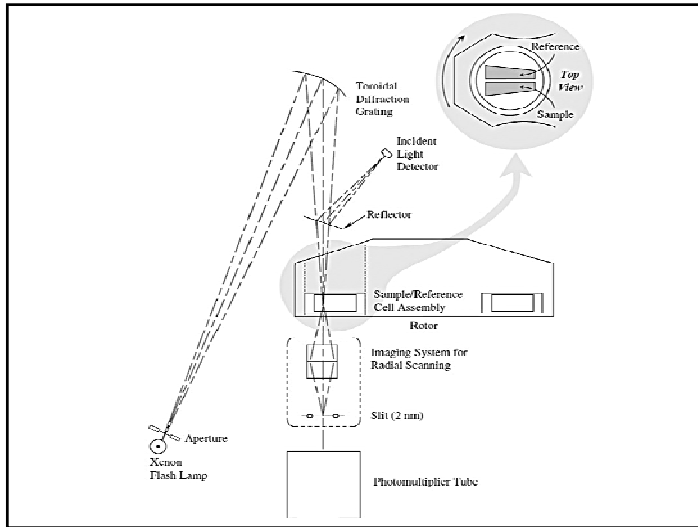

Figure 16. Sedimentation equilibrium distribution of two different solutes. Data were simulated for two species: (○) $M_r = 40,000$; (△) $M_r = 80,000$. The angular velocity was 15,000 rpm, and a partial specific volume of 0.73 was assigned to both species. The distribution of total solute concentration in the cell is also shown (●).

Sedimentation Equilibrium

At Equilibrium, the total flow is zero, and diffusion and sedimentation exactly balance out:

$$J = s\omega^2 rC - D \frac{\partial C}{\partial r} = 0$$

Therefore:

$$s\omega^2 rC = D \frac{\partial C}{\partial r}$$

Since:

$$\frac{s}{D} = \frac{M(1-\bar{v}\rho)}{RT}$$

$$\frac{\partial C}{C} = \frac{M\omega^2 r(1-\bar{v}\rho)}{RT} dr$$

Sedimentation Equilibrium

$$\int_{c_0}^{c_r} \frac{1}{C} dC = \frac{M \omega^2 (1 - \bar{v} \rho)}{RT} \int_{r_0}^{r_s} r dr$$

After Integration:

$$C = C_0 \exp \frac{M \omega^2 (1 - \bar{v} \rho)}{RT} (r^2 - r_0^2) + \text{Baseline}$$

The equilibrium gradient is dependent on rotor speed, temperature, an on the molecular weight and buoyancy of the solute. This equation can be fitted by nonlinear least squares.

$$\omega^2 r c \frac{M(1 - \bar{v} \rho)}{N_0 f} = \frac{kT}{f} \left(\frac{dc}{c r} \right) \implies \omega^2 r c M(1 - \bar{v} \rho) = N_0 kT \left(\frac{dc}{dr} \right)$$

Separate the variables and integrate the differential equation over r_0 to r and from c_0 to c_r :

$$M(1 - \bar{v} \rho) \omega^2 \int_{r_0}^r r dr = RT \int_{c_0}^{c_r} \frac{1}{c} dc \implies M(1 - \bar{v} \rho) \omega^2 \frac{1}{2} (r^2 - r_0^2) = RT \ln \frac{c_r}{c_0}$$

$$\implies \ln c_r = \frac{M(1 - \bar{v} \rho) \omega^2}{2RT} r^2 - \frac{M(1 - \bar{v} \rho) \omega^2}{2RT} r_0^2 + \ln c_0$$

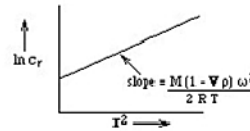

This equation has the form of the equation of a straight line, $y = m x + b$, where $\ln c_r = y$ and $r^2 = x$.

If we plot $\ln c_r$ vs. r^2 , the result should be a straight line

with a slope = $\frac{M(1 - \bar{v} \rho) \omega^2}{2RT}$. Concentration, c , can be measured at each radius, r , using optical systems built into analytical ultracentrifuges.

