

## Binding

“The secret of life is molecular recognition; the ability of one molecule to "recognize" another through weak bonding interactions.”

*Linus Pauling at the 25th anniversary of the Institute of Molecular Biology at the University of Oregon*

**Binding is the first step necessary for a biological response.**

To understanding binding, we must consider the equilibria involved, how binding is affected by ligand and macromolecule concentration, and how to experimentally analyze and interpret binding data and binding curves.

*Hackert – CH370*

## Ligand Binding

- **General description of ligand binding**
- **Simple equilibrium binding**
  - stoichiometric titration
- **Complex equilibrium binding**
  - Multiple sites / cooperativity
  - Microscopic vs. Macroscopic binding constants
  - Scatchard plots and Hill Plots
- **Measuring binding constants**
  - Equilibrium dialysis / Fluorescence techniques
  - ITC (Isothermal Titration Calorimetry)
  - SPR (Surface Plasmon Resonance)

## Summary of Key Equations / Relationships

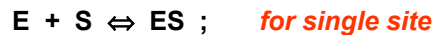

$$K_d = k_{\text{off}} / k_{\text{on}} = [E][S]/[ES] \quad \text{and} \quad K_a = 1 / K_d$$

$$S_o = S + ES; \quad E_o = E + ES$$

define **Fractional Occupancy** of sites

$$\theta = [ES]/[E_o] = [ES]/([E] + [ES]) \times [S]/[S] \times [1/ES]/[1/ES]$$

$$\text{then} \quad \theta = [S]/(K_d + [S])$$

$$\text{thus when } [S] = K_d, \text{ then } \theta = 0.50$$

$$\text{when } [S] = 4K_d, \text{ then } \theta = 0.80$$

$$\text{when } [S] = 10K_d, \text{ then } \theta = 0.91$$

**Note: [S] = conc. of free ligand!!**

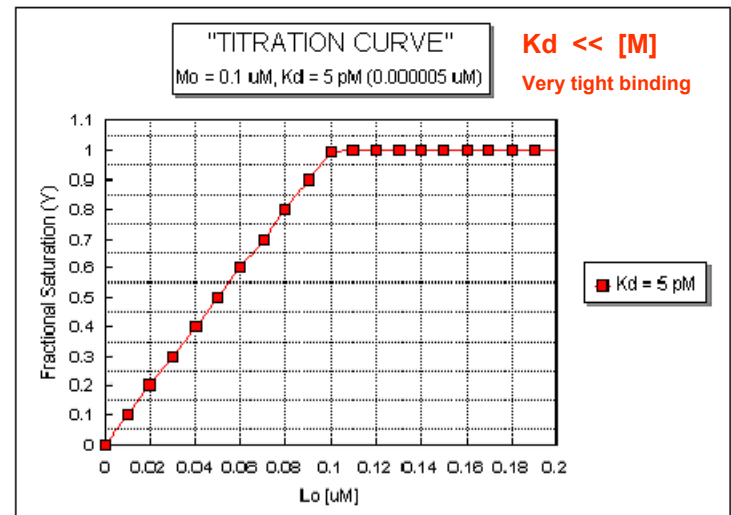

## Simplification of Key Equations

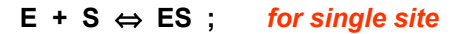

$$K_d = k_{\text{off}} / k_{\text{on}} = [E][S]/[ES] \quad \text{and} \quad K_a = 1 / K_d$$

$$S_o = S + ES; \quad E_o = E + ES$$

-----

If  $S_o \gg E_o$ , then  $S \sim S_o$

$$\text{then } K_d [ES] = [E_o - ES][S_o]$$

$$[ES] = E_o S_o / (K_d + S_o);$$

define **Fractional Occupancy** of sites

$$\theta = [ES]/[E_o] = [ES]/([E] + [ES]) = [S_o]/(K_d + [S_o])$$

thus when  $[S_o] = K_d$ , then  $\theta = 0.5$

→ Plot  $\theta$  vs.  $[S_o]$  (hyperbolic curve)

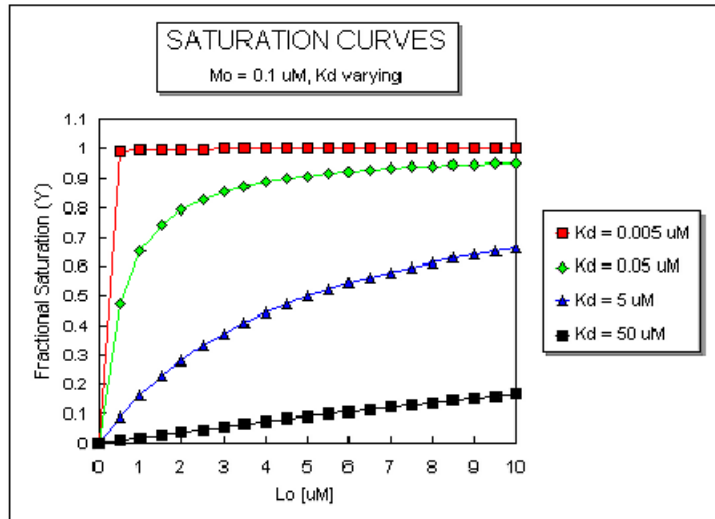

## No Assumptions - Key Equations

Derivation of quadratic equation--with no assumptions concerning substrate concentration.

$$\text{fraction } \theta = [ES]/[E]_o = [ES]/([E] + [ES]) \quad \text{The derivation starts the same as above}$$

$$\theta = \frac{K_a[E][S]}{[E] + K_a[E][S]} = \frac{K_a[S]}{1 + K_a[S]} = \frac{[S]}{1/K_a + [S]} \quad \text{Fraction of sites bound relative to [S]}$$

$$\theta = \frac{[S]}{K_d + [S]} = \frac{[S]_o - [ES]}{K_d + [S]_o - [ES]} = \frac{[ES]}{[E]_o} \quad \text{Substitution of [S]=[S]_o-[ES]}$$

$$[ES](K_d + [S]_o) - [ES]^2 = [E]_o[S]_o - [ES][E]_o$$

$$[ES]^2 - [ES](K_d + [S]_o + [E]_o) + [E]_o[S]_o = 0 \quad \text{Form of equation require solution as the roots of the quadratic equation}$$

## No Assumptions - Key Equations

Solution is quadratic equation:

$$ax^2 + bx + c = 0$$

solution provided by the roots of the quadratic

$$x = \frac{-b \pm \sqrt{b^2 - 4ac}}{2a}$$

$$[ES] = \frac{(E_o + S_o + K_d) - \sqrt{(E_o + S_o + K_d)^2 - 4 \cdot E_o \cdot S_o}}{2}$$

$$\theta = \frac{(E_o + S_o + K_d) - \sqrt{(E_o + S_o + K_d)^2 - 4 \cdot E_o \cdot S_o}}{2 \cdot E_o}$$

This equation must be used rather than the hyperbola whenever the enzyme concentration is comparable or greater than the dissociation constant. As a general rule, if  $[E]_o$  is less than 5 times the  $K_d$ , the hyperbolic fit is probably adequate.

# Increasing complexity Multiple Binding Sites

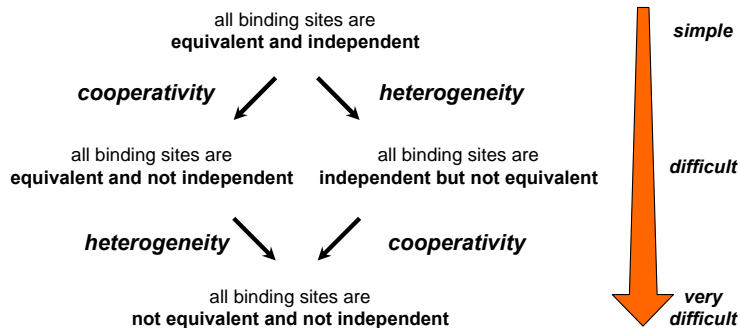

## Difference between microscopic and macroscopic dissociation constant

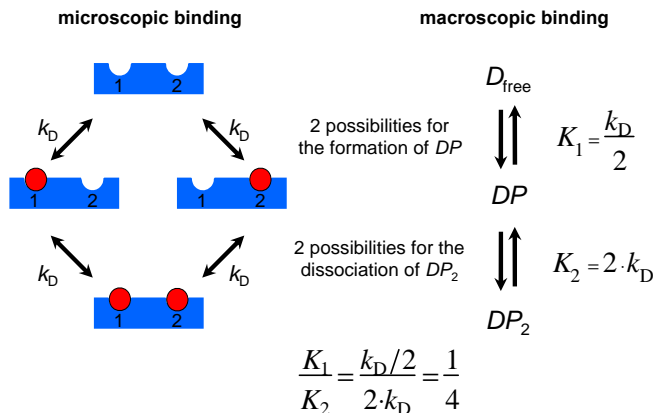

Solution of fraction of sites occupied for a two-step binding sequence.

Mass balance equations:

$$[E]_0 = [E] + [ES_1] + [ES_2]$$

$$[S]_0 = [S] \text{ (negligible amount bound)}$$

Fraction of sites bound:

$$\theta = \frac{[ES_1] + [ES_2]}{[E]_0}$$

$$= \frac{[ES_1] + [ES_2]}{[E] + [ES_1] + [ES_2]}$$

Substitution of bound states:

$$[ES_1] = K_1[E][S]$$

$$[ES_2] = K_2[ES_1][S] = K_1K_2[E][S]^2$$

$$\theta = \frac{K_1[E][S] + K_1K_2[E][S]^2}{[E] + K_1[E][S] + K_1K_2[E][S]^2}$$

$$\theta = \frac{K_1[S] + K_1K_2[S]^2}{1 + K_1[S] + K_1K_2[S]^2}$$

Fraction of sites bound

If the equations are defined for moles of substrate bound per mole of dimers instead of per mole of active sites, the equations becomes:

$$v = \frac{K_1[S] + 2K_1K_2[S]^2}{1 + K_1[S] + K_1K_2[S]^2} \quad \text{where } v = \frac{\text{moles S bound}}{\text{mole of dimers}}$$

Accordingly, the binding equation ranges from 0-2 moles bound rather than from 0-1 fraction of sites occupied.

## Multiple Binding Equilibria

### Multiple Binding Sites:

Reaction step

Association constant

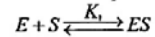

$$[ES] = K_1[E][S]$$

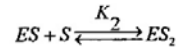

$$[ES_2] = K_2[ES][S] = K_1K_2[E][S]^2$$

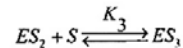

$$[ES_3] = K_3[ES_2][S] = K_1K_2K_3[E][S]^3$$

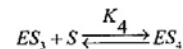

$$[ES_4] = K_4[ES_3][S] = K_1K_2K_3K_4[E][S]^4$$

## Manipulations of Equations

### a) double reciprocal plot

$$1/\theta = K_d/[S] + 1 ; \text{ plot } 1/\theta \text{ vs. } 1/[S]$$

### b) Scatchard Plot: $\theta = [S]/(K_d + [S])$ or

$$\theta K_d + \theta[S] = [S] \text{ or } \theta = 1 - \theta K_d/[S]$$

$$\text{plot } \theta \text{ vs. } \theta/[S] \text{ slope} = -K_d$$

Linearized forms of the equation:

#### a) Double Reciprocal Plot

$$1/\theta = \frac{[S] + K_d}{[S]} = 1 + \frac{K_d}{[S]}$$

Or for multiple sites:

$$1/\nu = \frac{[S] + K_d}{[S]} = n + \frac{K_d}{[S]}$$

#### b) Scatchard Plot

$$\theta = 1 - \frac{\theta K_d}{[S]}$$

Or for multiple sites:

$$\theta = n - \frac{\nu K_d}{[S]}$$

$$\nu = \frac{\text{moles bound}}{\text{mole E}} = n\theta$$

## EXPERIMENTAL DETERMINATION OF K<sub>d</sub>

**TECHNIQUES THAT REQUIRE SEPARATION OF BOUND FROM FREE LIGAND** – Care must be given to ensure that the equilibrium of  $M + L \rightleftharpoons ML$  is not shifted during the separation technique.

• **gel filtration chromatography** - Add M to a given concentration of L. Then elute the mixture on a gel filtration column, eluting with the free ligand at the same concentration. The ML complex will elute first and can be quantitated. If you measure the free ligand coming off the column, it will be constant after the ML elutes with the exception of a single dip near where the free L would elute if the column was eluted without free L in the buffer solution. This dip represents the amount of ligand bound by M.

• **membrane filtration** - Add M to radiolabeled L, equilibrate, and then filter through a filter which binds M and ML. For instance, a nitrocellulose membrane binds proteins irreversibly. Determine the amount of radiolabeled L on the membrane which equals [ML].

• **precipitation** - Add a precipitating agent like ammonium sulfate, which precipitates proteins and hence both M and ML. Determine the amount of ML.

## EXPERIMENTAL DETERMINATION OF K<sub>d</sub>

**TECH. THAT DO NOT REQUIRE SEPARATION OF BOUND FROM FREE LIGAND**

• **Equilibrium dialysis** - Place M in a dialysis bag and dialyse against a solution containing a ligand whose concentration can be determined using **radioisotopic** or **spectroscopic** techniques.

• **Fluorescence spectroscopy** - Find a ligand whose absorbance or fluorescence spectra changes when bound to M. Alternatively, monitor a group on M whose absorbance or fluorescence spectra changes when bound to L.

• **Other (higher tech) methods:**

**ITC - Isothermal Titration Calorimetry**

**SPR – Surface Plasmon Resonance**

**Fast Kinetics**

## Equilibrium Dialysis

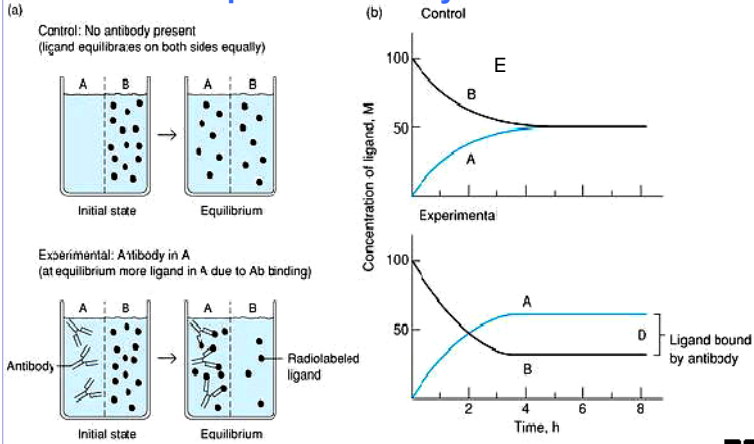

At equilibrium, determine free [L] by sampling the solution on side "B" and total [L] from side "A". By mass balance, determine the amount of bound ligand. Repeat at different ligand concentrations.

## Spectroscopy

### Fluorescence Spectroscopy

$$F = F_0 + \Delta F \cdot \theta$$

$$\text{where } \Delta F = F_{\infty} - F_0$$

and  $\theta$  is defined by either:

$$\theta = \frac{[S]_0}{K_d + [S]_0} \quad \text{OR} \dots$$

This equation normalizes the observable signal to a scale that can be related to fractional occupancy,  $\theta$ .

$$\theta = \frac{(E_0 + S_0 + K_d) - \sqrt{(E_0 + S_0 + K_d)^2 - 4 \cdot E_0 \cdot S_0}}{2 \cdot E_0}$$

### Fluorescence Anisotropy

Definition of fluorescence anisotropy  $r$

$$r = \frac{I_{\parallel} - I_{\perp}}{I_{\parallel} + 2I_{\perp}}$$

$$\theta = \frac{[P_{\text{tot}}]}{[P_{\text{tot}}] + K_D} = \frac{r_{\text{measured}} - r_{\text{min}}}{r_{\text{max}} - r_{\text{min}}}$$

## How to measure binding of a protein to DNA? One possibility is to use fluorescence anisotropy

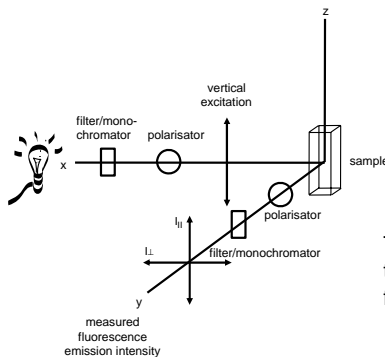

Definition of fluorescence anisotropy  $r$

$$r = \frac{I_{\parallel} - I_{\perp}}{I_{\parallel} + 2I_{\perp}}$$

The anisotropy  $r$  reflects the rotational diffusion of a fluorescent species

## Analysis of binding of RNAP- $\sigma^{54}$ to a promoter DNA sequence by measurements of fluorescence anisotropy

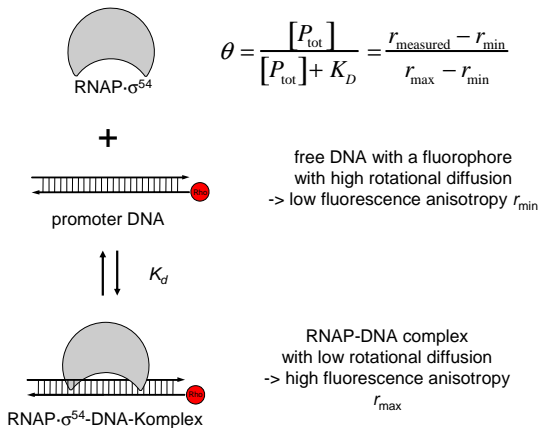

Note: DNA binding examples from Karsten Rippe - Heidelberg

## Measurements of fluorescence anisotropy to monitor binding of RNAP- $\sigma^{54}$ to different promoters

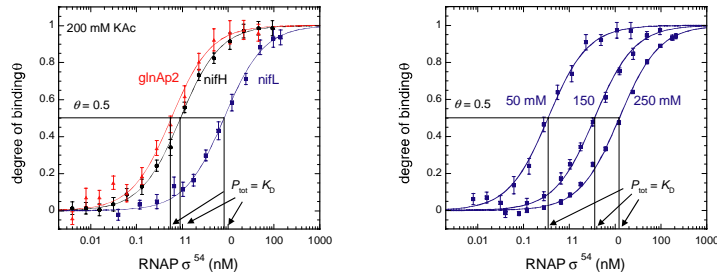

Vogel, S., Schulz A. & Rippe, K.

Direct comparison of binding equilibrium, thermodynamic, and rate constants determined by surface- and solution-based biophysical methods  
*(Binding of Small Molecules CBS & DNSA to Carbonic Anhydrase II)*  
 Protein Science (2002), 11:1017–1025.

YASMINA S.N. DAY, CHERYL L. BAIRD, REBECCA L. RICH, AND DAVID G. MYSZKA  
 Center for Biomolecular Interaction Analysis, University of Utah, School of Medicine,  
 Salt Lake City, Utah 84132, USA

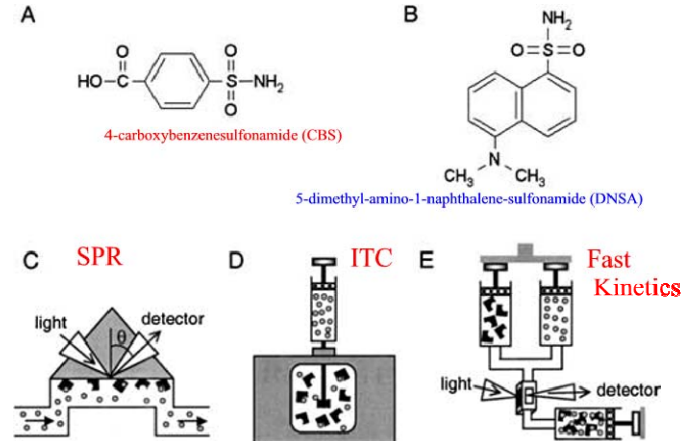

## Thermodynamics and Binding Constants (K)

### $\Delta G$ , $\Delta G^0$ of a reaction at equilibrium

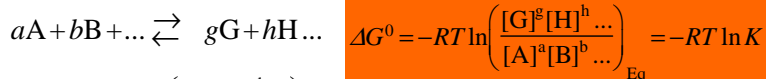

$$0 = \Delta G^0 + RT \ln \left( \frac{[G]^g [H]^h \dots}{[A]^a [B]^b \dots} \right)_{Eq}$$

$$K = \left( \frac{[G]^g [H]^h \dots}{[A]^a [B]^b \dots} \right)_{Eq} = \exp \left( \frac{-\Delta G^0}{RT} \right)$$

$$\Delta G^0 = \Delta H^0 - T \Delta S^0$$

van't Hoff Equation

$$\ln K = \frac{-\Delta H^0}{RT} + \frac{\Delta S^0}{R}$$

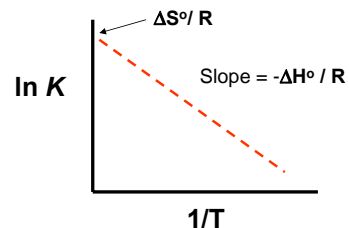

## ITC: Isothermal Calorimetry

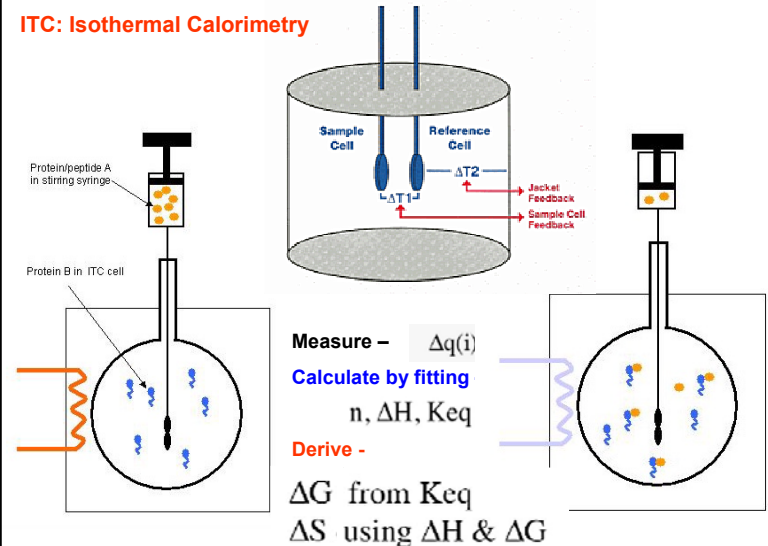

## ITC: Isothermal Titration Calorimetry

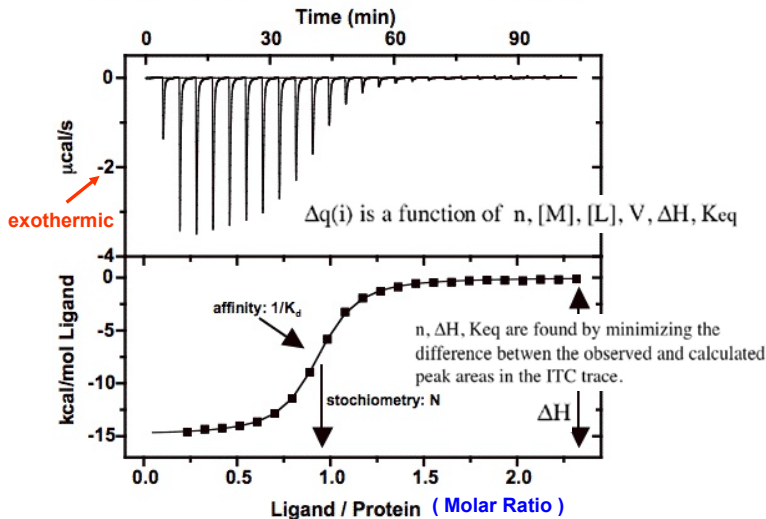

## Binding - SPR or BIA

“The secret of life is molecular recognition”

“Binding is the first step necessary for a biological response”

**Biacore’s SPR technology:** label-free technology for *monitoring biomolecular interactions as they occur.*

The detection principle relies on **surface plasmon resonance (SPR)**, an **electron charge density wave phenomenon** that arises at the surface of a metallic film when light is reflected at the film under specific conditions.

The resonance is a result of **energy and momentum being transformed from incident photons into surface plasmons**, and is sensitive to the refractive index of the medium on the **opposite side of the film from the reflected light.**

Hackert – CH370

Note: Many of these figures/notes were taken from on-line resources from Biacore

## Objectives of the Biacore Experiment

- **Yes/No Data**  
– **Ligand Fishing**

**Concentration Analysis:**  
**How MUCH?**  
**Active Concentration**

**Solution Equilibrium**  
**Inhibition**

**Affinity Analysis:**  
**HOW STRONG?**

$K_D, K_A$   
**Relative Ranking**

- **Kinetic Rate Analysis:**
- **How FAST?**
  - $k_a, k_d$
  - $K_D = k_d/k_a, K_A = k_a/k_d$

## Plasmons & SPR “angle”

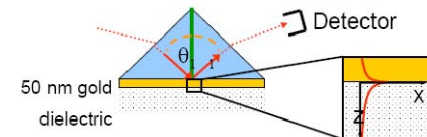

Measure reflected (polarized) light as function of angle.

At a certain “**Magic Angle**” light is not reflected (“total internal reflection”) but interacts with free electrons in gold to form a resonant energy wave – or surface plasmon.

**Plasmon** – A plasmon is a collective oscillation of the conduction electrons in a metal - a quasiparticle that can be regarded as a hybrid of the conducting electrons and the photon.

Angle is sensitive to **refractive index** of dielectric which varies with concentration of molecules on the other side of gold layer!

## Total Internal Reflection (TIR) for a non-absorbing media

Light propagating in a medium of refractive index  $n_1$  undergoing total internal reflection at the interface with the medium of a lower refractive index  $n_2$ . The evanescent field,  $E$ , is a non-transverse wave having components in all spatial orientations, decreasing in field intensity with penetration into medium of  $n_2$ .  $\theta$  is the angle of incidence.

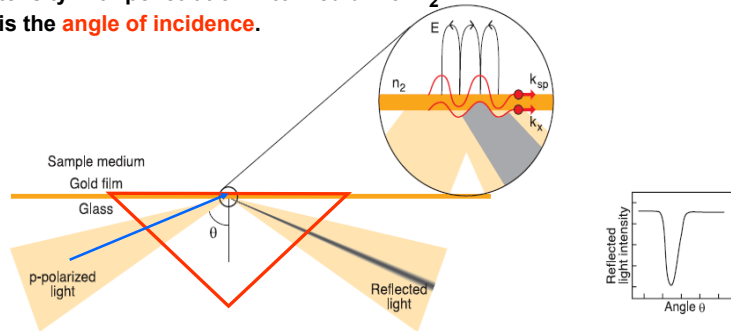

## SPR - The need for Gold

The actual SPR signal can be explained by the electromagnetic 'coupling' of the incident light with the surface plasmon of the gold layer. **This plasmon can be influenced by the layer just a few nanometer across the gold-solution interface, i.e. the bait protein and possibly the prey protein. Binding makes the reflection angle change.**

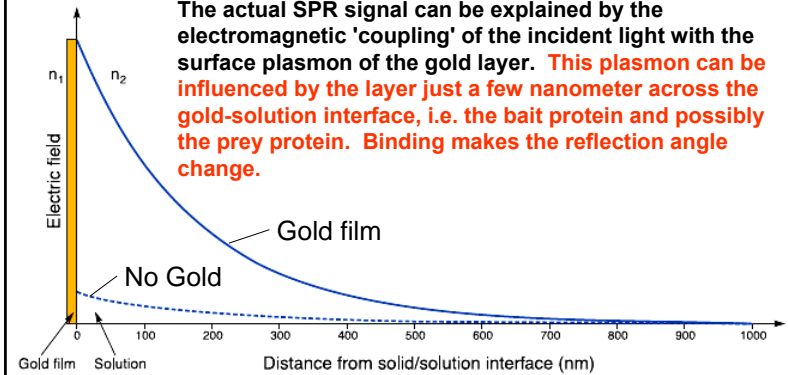

## Three Corner Stones of Biacore Technology

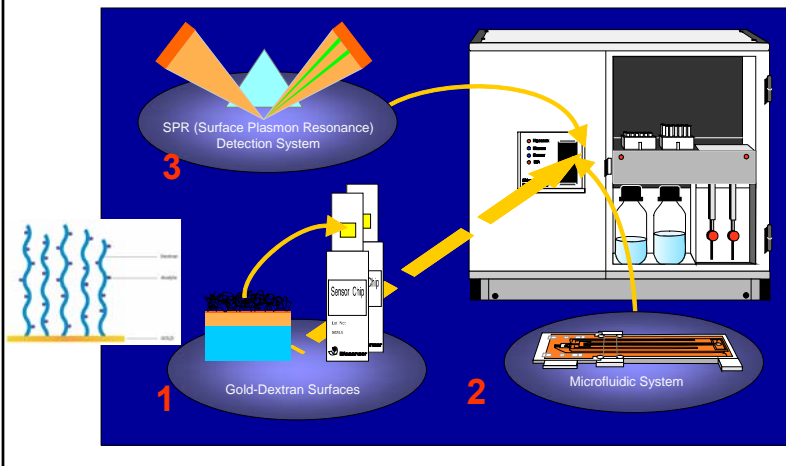

**1.** The **Biacore sensor chip** is at the heart of the technology. Quantitative measurements of the binding interaction between one or more molecules are dependent on the **immobilization of a target molecule to the sensor chip surface**. **Binding partners to the target can be captured from a complex mixture**, in most cases, **without prior purification** (for example, clinical material, cell culture media) as they pass over the chip. Interactions between proteins, nucleic acids, lipids, carbohydrates and even whole cells can be studied. **The sensor chip consists of a glass surface, coated with a thin layer of gold**. This forms the basis for a range of specialized surfaces designed to optimize the binding of a variety of molecules.

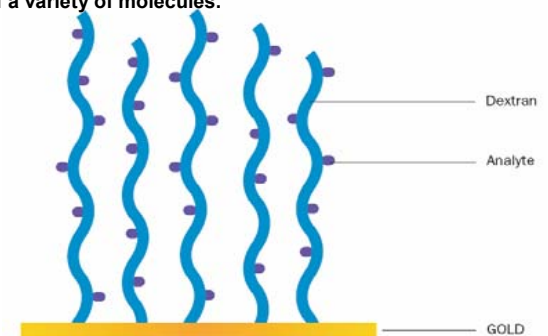



## 2. Integrated micro Fluidics Cartridges (IFC)

### Liquid Handling

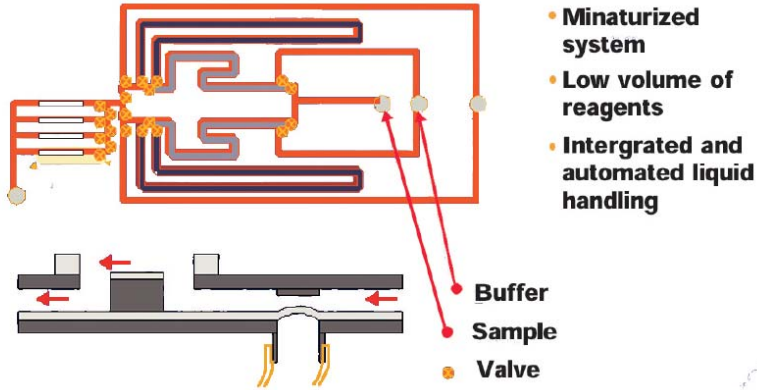

## 3. Surface Plasmon Resonance Detection: Biomolecular Binding in Real Time

### Principle of Detection

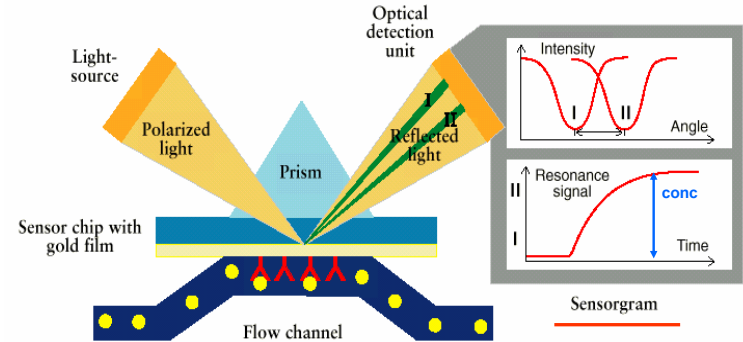

## The Sensorgram is Information Rich

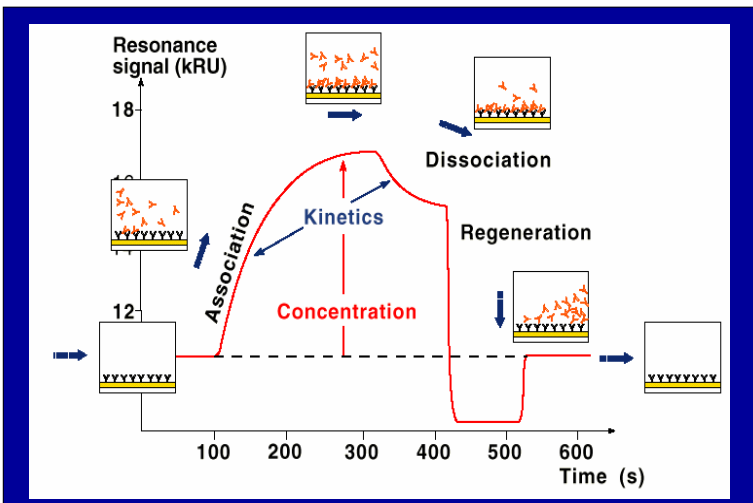

## Same affinity but different kinetics

- All 4 compounds have the **same affinity**  $K_D = 10 \text{ nM} = 10^{-8} \text{ M}$
- The binding **kinetic constants vary by 4 orders** of magnitude

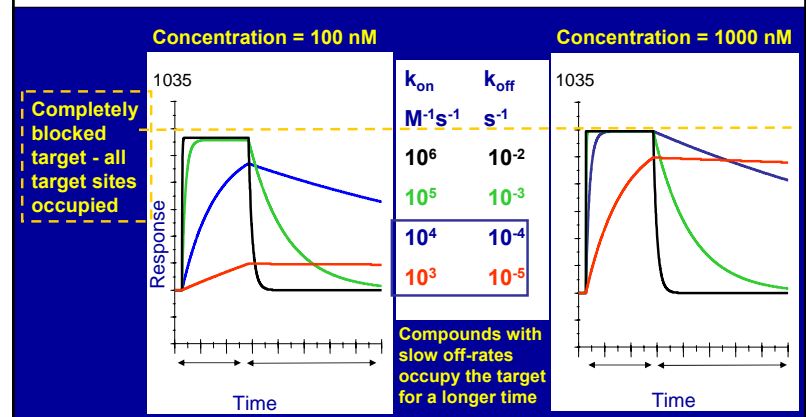

## HIV-p inhibitors: on-off rate map

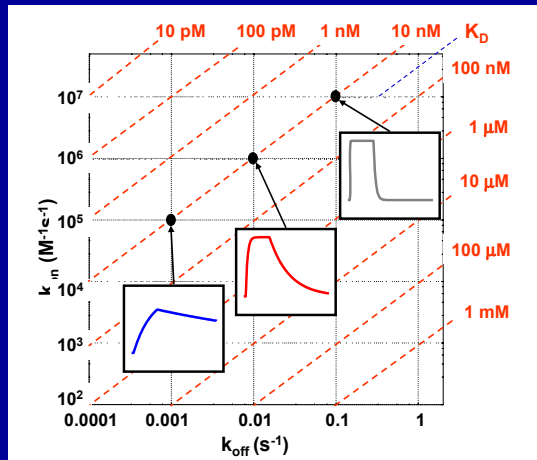

## Kinetic Effects of Alterations in the Z-domain of Protein A

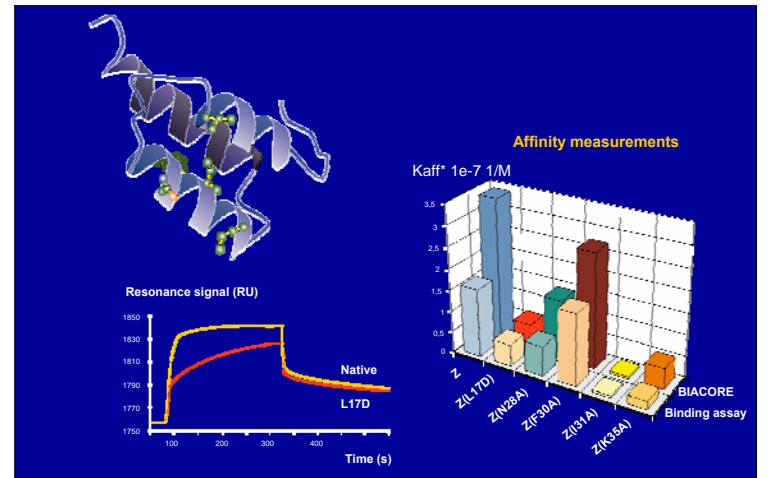

## SPR technology

- Non-label
- **Real-time**
- **Unique, high quality data** on molecular interactions
- **Simple assay** design
- Robust and reproducible
- Walk-away automation
- **Small amount of sample** required

## Flexibility in Assay Design

- **Multiple assay formats providing complementary data**

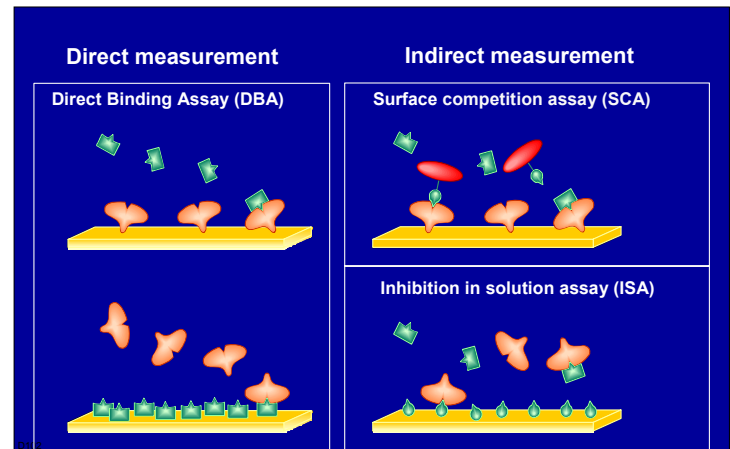

## Applications in Proteomics

- Fast, simple and compatible with any biological sample
- Monitors binding of native proteins from crude or purified samples
- Detects even low affinity binding events
- Recovers samples for MS analysis and identification
- Confirms results from other techniques
- Provides functional (interaction) data

## Biacore Proteomics Study

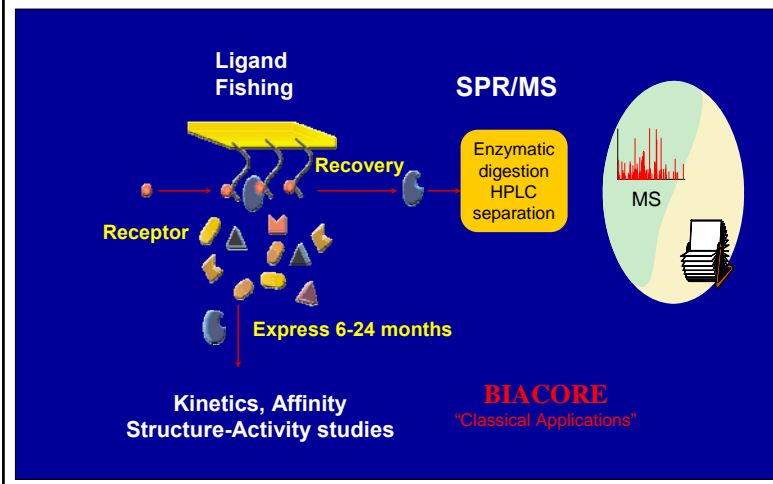

## Summary

- SPR detects binding events as **changes in mass at the chip surface**
- **Real-time kinetic measurements**
- Qualitative rankings
- Measurement of **active concentration**
- Information about **structure-activity relationships**
- **Low volumes** of precious samples needed

**BUT !!! -**

SPR is not a true solution method (vs. ITC)

Attaching receptor to surface can influence binding properties.